



IMOSTEEL

**STRUCTURI PREFABRICATE
DIN BETON ȘI METAL**

CUPRINS

MISIUNE, VIZIUNE, CINE SUNTEM	3
AVANTAJELE PARTENERIATULUI CU IMOSTEEL	5
STRUCTURI DE REZISTENȚĂ CONCEPTE SPECIFIC PENTRU FIECARE PROIECT	6
INTEGRAL BETON	9
FUNDAȚII PREFABRICATE	9
STÂLPI	10
GRINZI DE ACOPERIȘ	11
SECȚIUNE STRUCTURĂ INTEGRAL BETON	15
SECȚIUNE GRINZI DE ACOPERIȘ	15
PANE, PEREȚI PREFABRICAȚI, PLANȘEU	16
MIXT	17
FUNDAȚII - STÂLPI DE BETON ȘI ȘARPANTĂ METALICĂ	17
STÂLPI BETON	18
STÂLPI CU INSERT PENTRU PLANȘEU	18
STRUCTURĂ MIXTĂ (FERME METALICE)	19
METAL	20
FUNDAȚII PREFABRICATE (OBELIX)	20
PENTRU STRUCTURI METALICE	
HALE DIN PROFILE METALICE	21

VIZIUNE

Viitorul tău merită tot ce e mai bun; hai să îl construim împreună.

MISIUNE

Cu o experiență de peste 32 de ani, misiunea noastră este să construim structuri industriale, prin soluții optime, care asigură calitatea și durabilitatea.

CINE SUNTEM

Imosteel este singura societate din România care produce în fabrica proprie structuri prefabricate din beton și metal. Avem o capacitate de producție de 100.000 mp/an **exclusiv în sectorul industrial.**

Imosteel realizează o cifră de afaceri de peste 12 mil. euro, cu o creștere constantă de la an la an și demonstrează stabilitate financiară și succes pe termen lung.

Ca societate, am finalizat peste 700 de proiecte de succes, reflectând angajamentul nostru față de calitate și satisfacția clientului. Oferim servicii complete, de la proiectare până la construcție, inclusiv finanțare, ceea ce ne face un partener de încredere pe piața construcțiilor industriale.

- PASUL 1. Analiză economică și consultanță în proiectare cu titlu gratuit.
- PASUL 2. Realizarea anteproiectului și a ofertei.
- PASUL 3. Contractarea și realizarea proiectului.
- PASUL 4. Producția elementelor componente și montarea acestora pe șantier.
- PASUL 5. Posibilitatea de finanțare a proiectului.

Realizăm, astfel, antrepriză generală la preț de producător.



AVANTAJELE PARTENERIATULUI CU IMOSTEEL

1. Oferim servicii complete în construirea unei hale industriale prin departamente proprii: proiectare, producție, montaj și finanțare.
2. Capitalul societății este 100% românesc.
3. Unitate de producție în fabrică întinsă pe 8000 mp.
4. Am construit peste 200.000 de metri pătrați.
5. Grupul Imosteel are peste 150 de angajați.
6. Încă din 1992 activăm pe segmentul industrial național și internațional.
7. Avem o capacitate de management concomitent a peste 30 de proiecte.

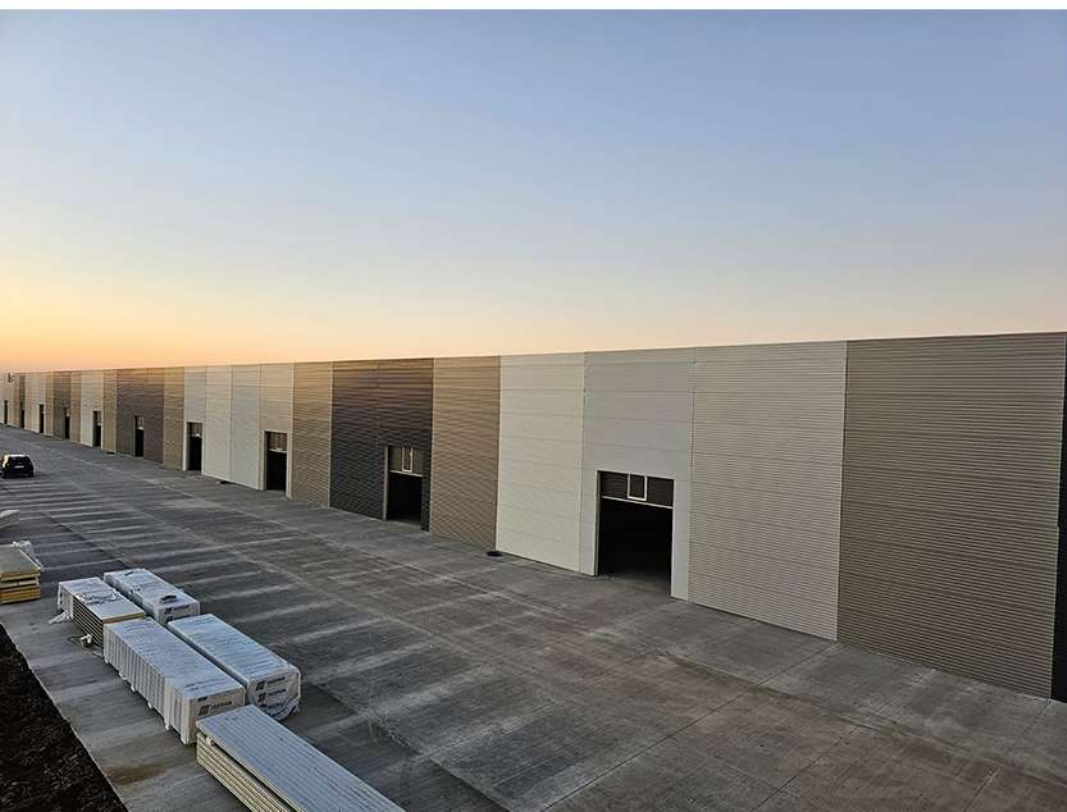

STRUCTURI DE REZISTENȚĂ CONCEPTE SPECIFIC PENTRU FIECARE PROIECT

INTEGRAL BETON

Presupune în întregime utilizarea prefabricatelor produse în fabrica proprie. Deschideri de până la 30 de metri.



MIXT

Fundații prefabricate, stâlpi din beton, ferme, pane, contravântuiri metalice. Deschideri de până la 34 de metri.



STRUCTURĂ METALICĂ

Fundații prefabricate obelisc pentru structură metalică, stâlpi, grinzi, pane, contravântuiri metalice. Deschideri de până la 32 de metri din structură metalică.







INTEGRAL BETON

FUNDAȚII PREFABRICATE

Pahar prefabricat și talpă din beton armat monolit

Dimensiuni:

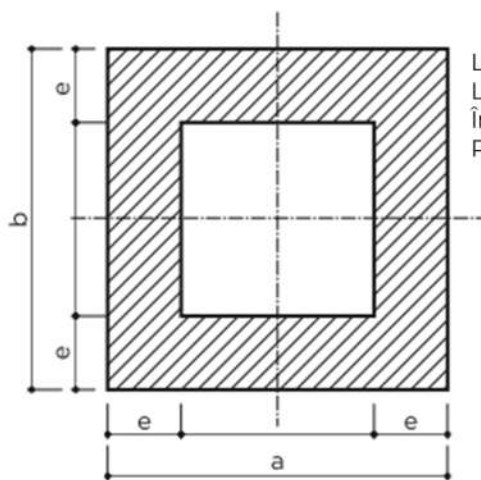

Lungime: a (m) 0,80 - 1,50
Lățime: b (m) 0,80 - 1,50
Înălțime: h (cm) 1,10 - 1,30
Perete: e (m) 0,25 - 0,45

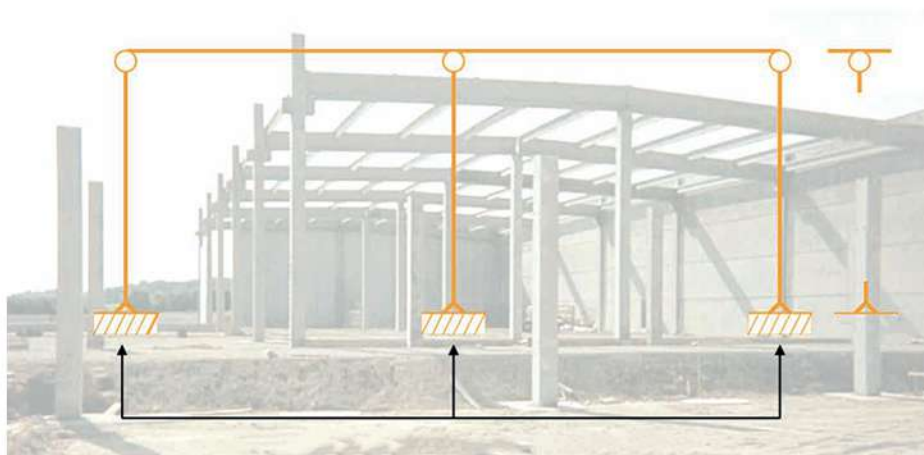
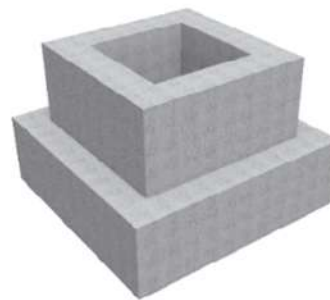
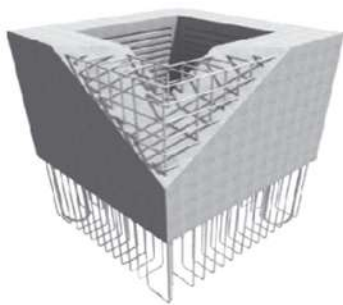
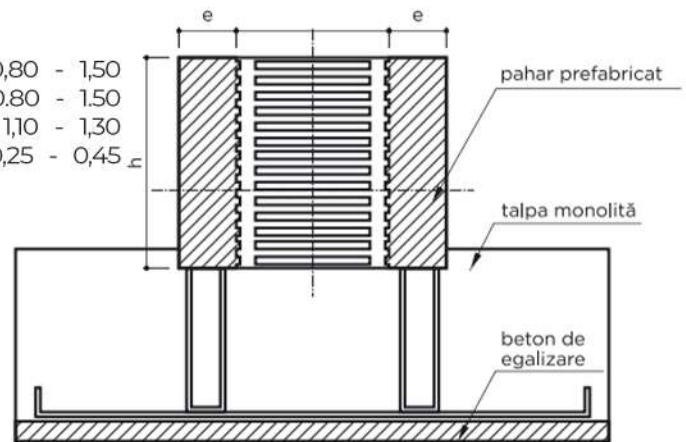

STÂLPI

Dimensiuni stâlpi

60 x 60

65 x 65

70 x 70

75 x 75

80 x 80

90 x 90

100 x 100

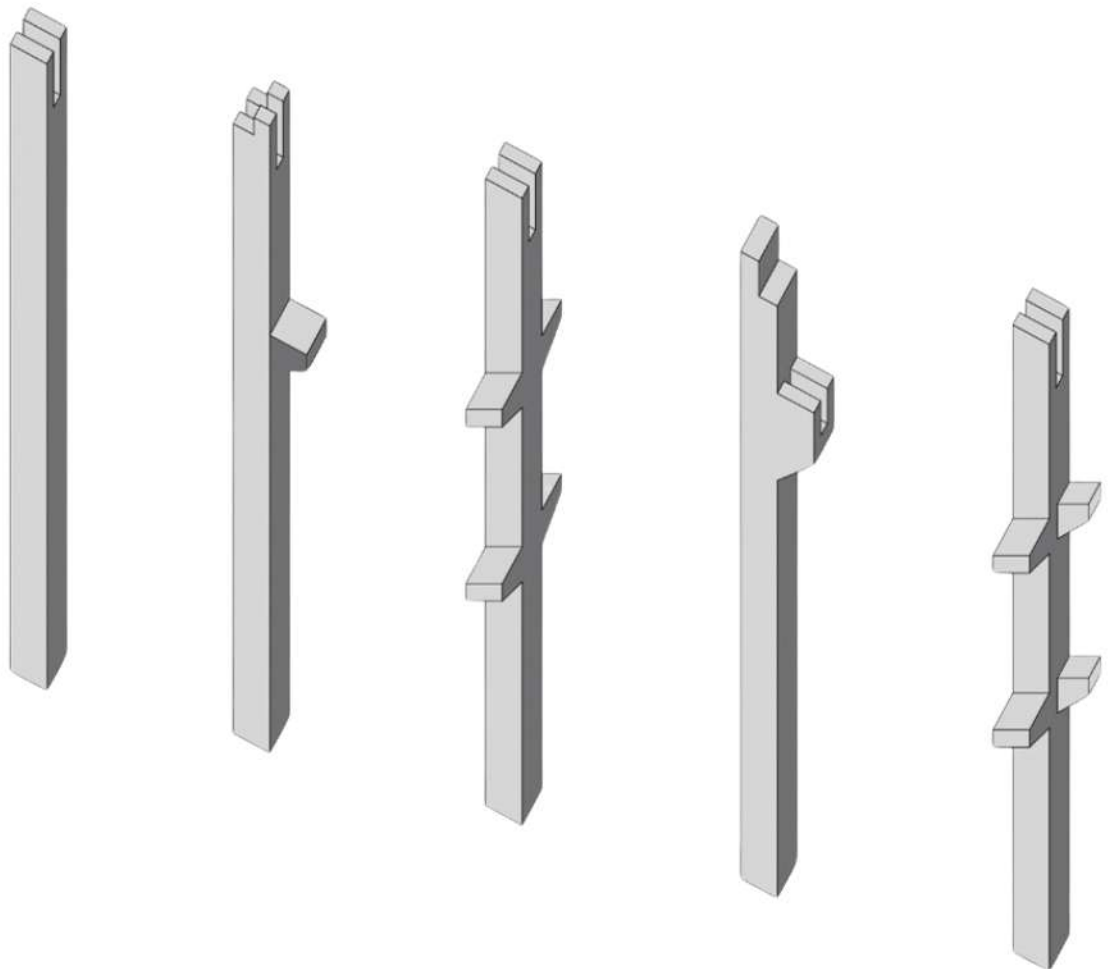

GRINZI DE ACOPERIȘ

GRINDĂ PREFABRICATĂ - 15 METRI

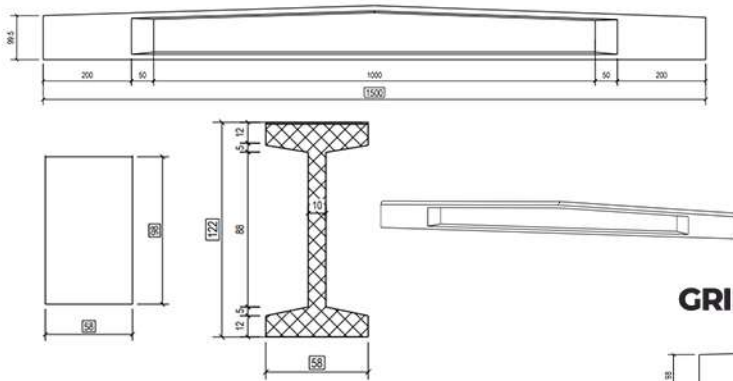

GRINDĂ PREFABRICATĂ - 16 METRI

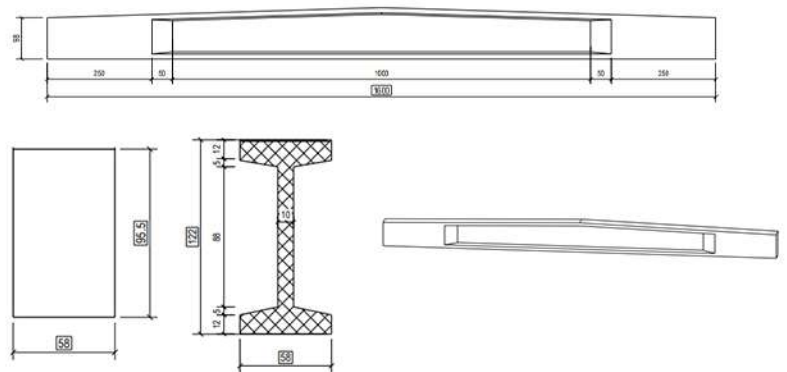

GRINDĂ PREFABRICATĂ - 17 METRI

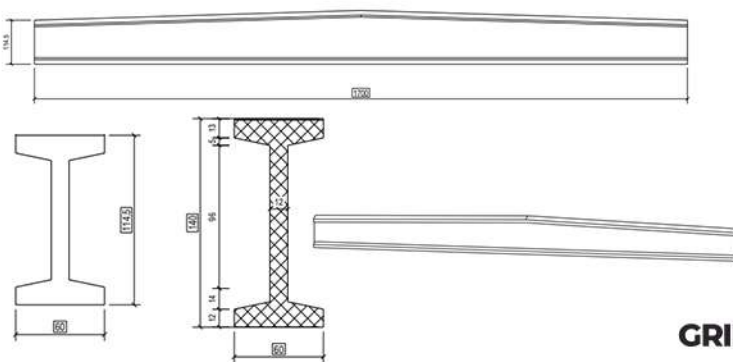

GRINDĂ PREFABRICATĂ - 18 METRI

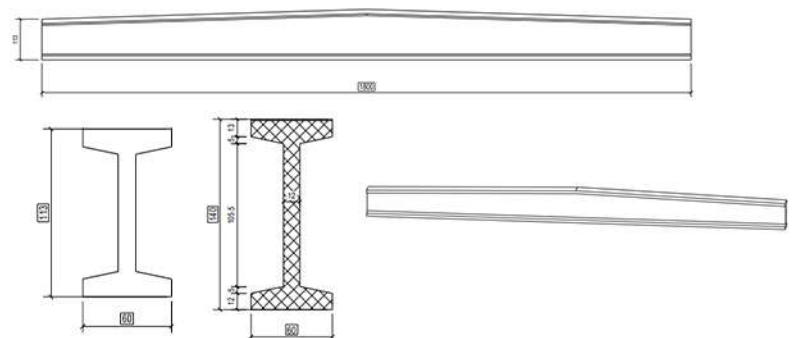

GRINDĂ PREFABRICATĂ - 19 METRI

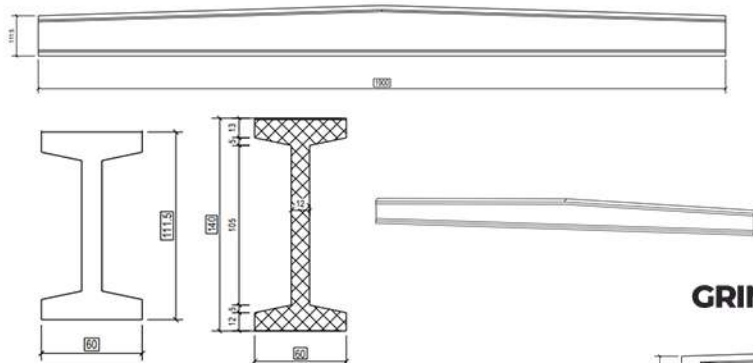

GRINDĂ PREFABRICATĂ - 20 METRI

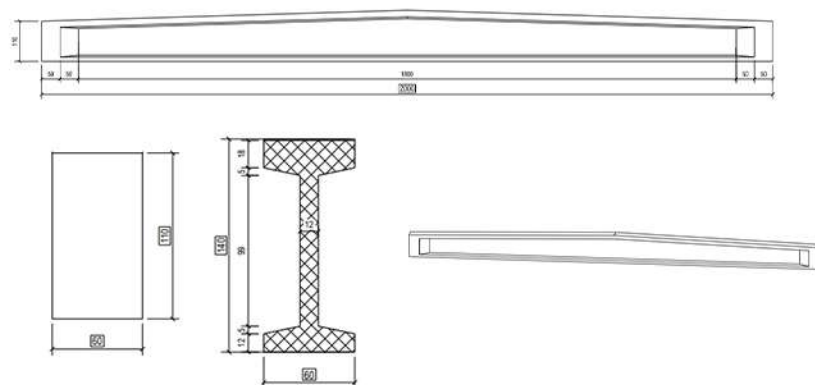

GRINDĂ PREFABRICATĂ - 21 METRI

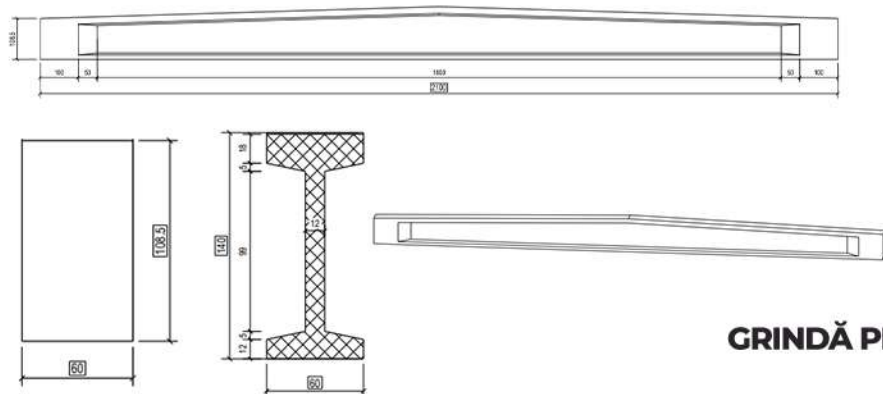

GRINDĂ PREFABRICATĂ - 22 METRI

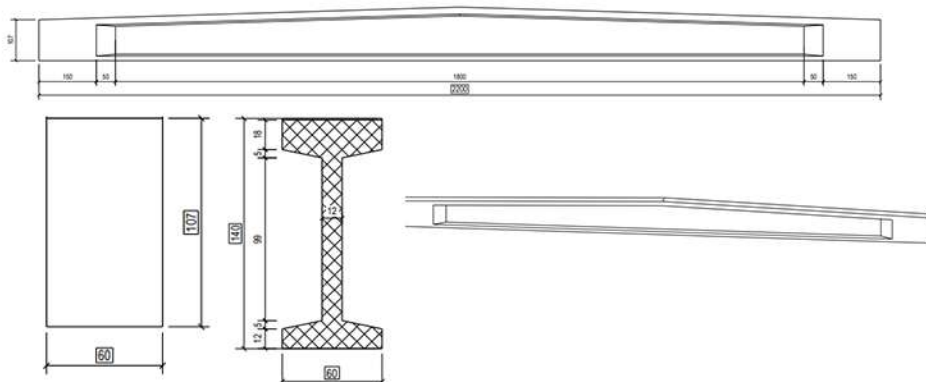

GRINDĂ PREFABRICATĂ - 23 METRI

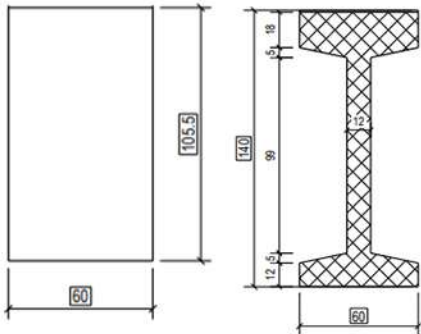
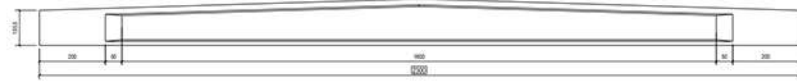

GRINDĂ PREFABRICATĂ - 24 METRI

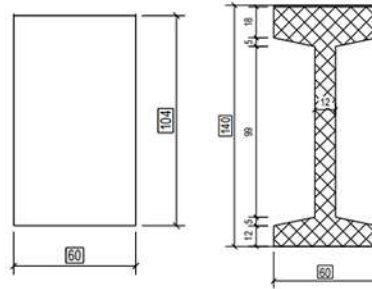
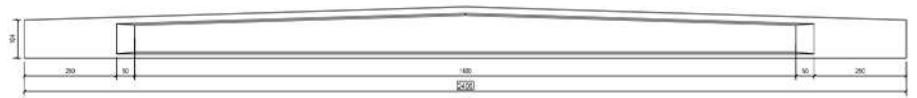

GRINDĂ PREFABRICATĂ - 25 METRI

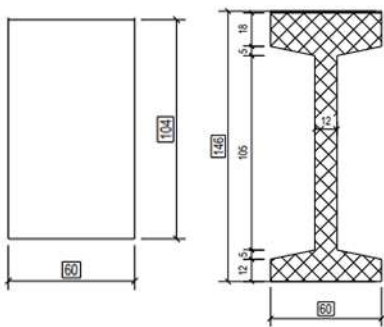

GRINDĂ PREFABRICATĂ - 26 METRI

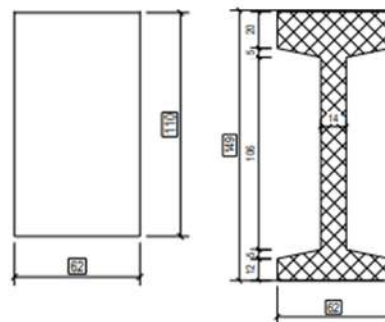
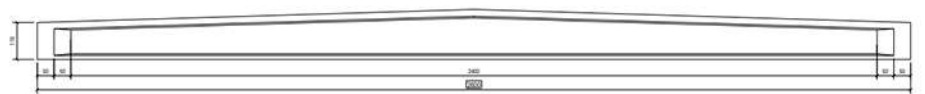

GRINDĂ PREFABRICATĂ - 27 METRI

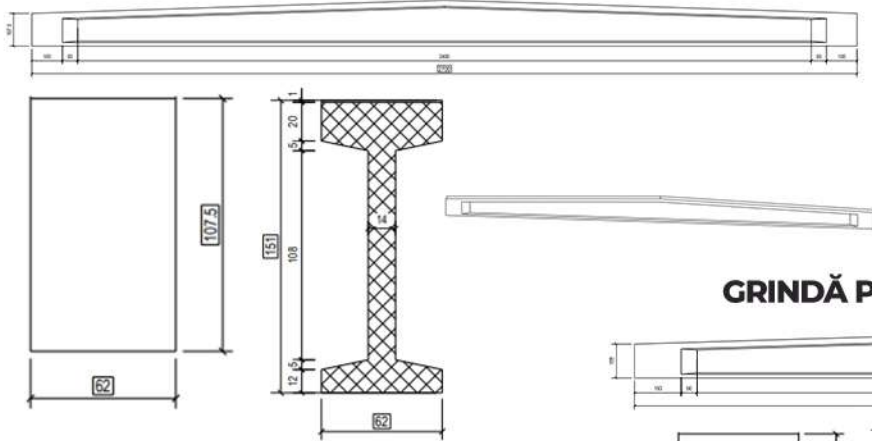

GRINDĂ PREFABRICATĂ - 28 METRI

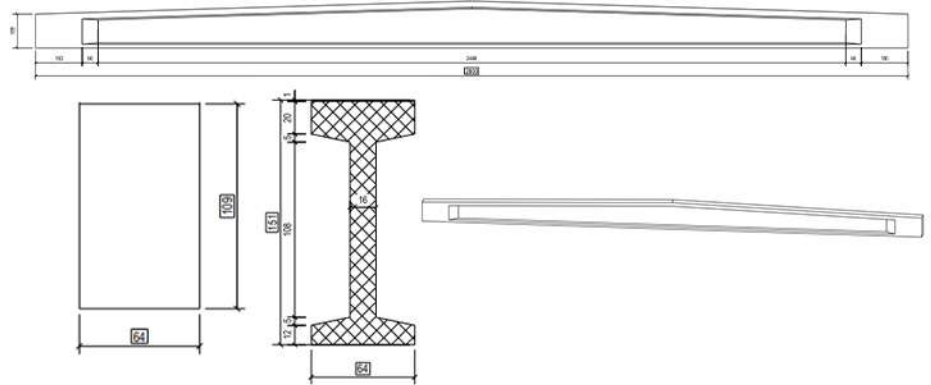

GRINDĂ PREFABRICATĂ - 29 METRI

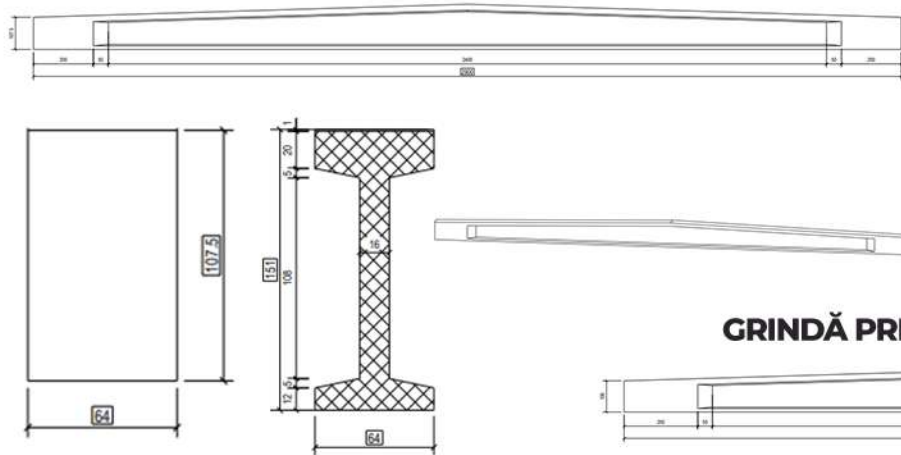

GRINDĂ PREFABRICATĂ - 30 METRI

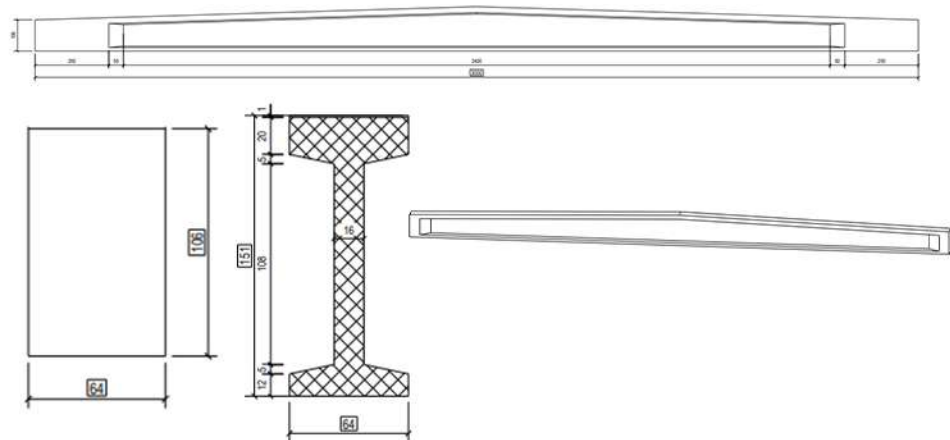

SECȚIUNE STRUCTURĂ INTEGRAL BETON

Domeniu de aplicare cu deschidere 20 - 30 mp.

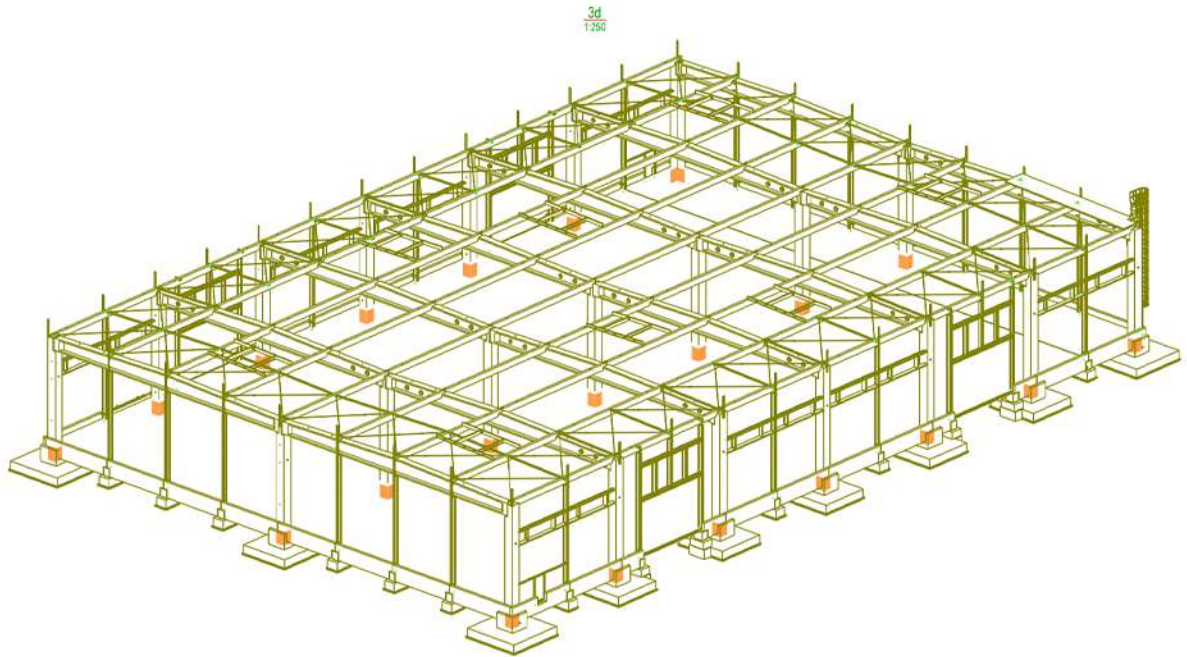

SECȚIUNE GRINZI DE ACOPERIȘ

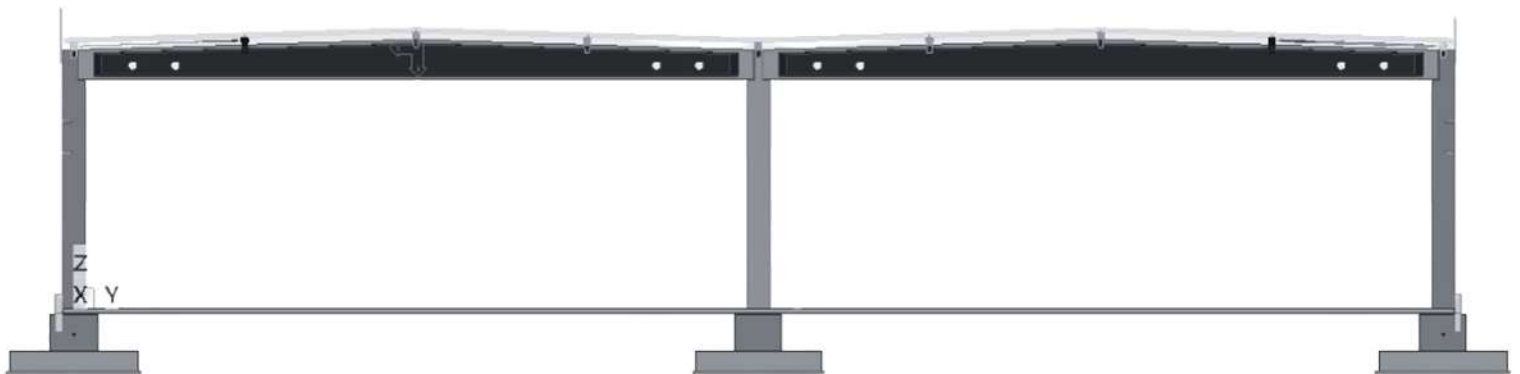

PANE

Baza mică a (cm)	Panta	Înălțime maximă h (cm)	Lungime maximă (m)
15	5%	90	25
20	5%	90	25

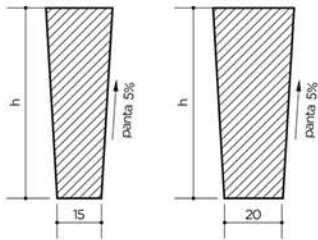

PEREȚI PREFABRICAȚI BETON

Tip Panou	Înălțime maximă Hmax (m)	Lungime maximă Lmax (m)	Grosime b (m)
Tristrat	2,5	6	0,20-0,25
Monostrat	2,5	6	0,15

PANOU TRISTRAT

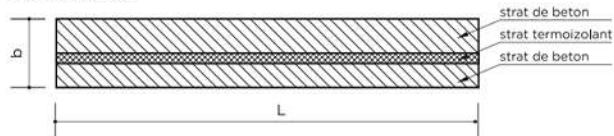

PANOU MONOSTRAT

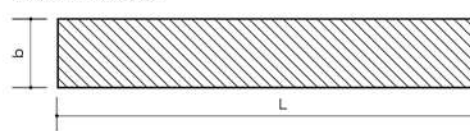

PLANȘEU

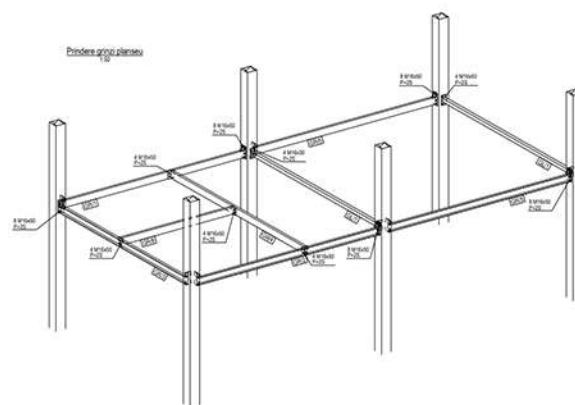

MIXT

FUNDAȚII - STÂLPI DE BETON ȘI ȘARPANTĂ METALICĂ

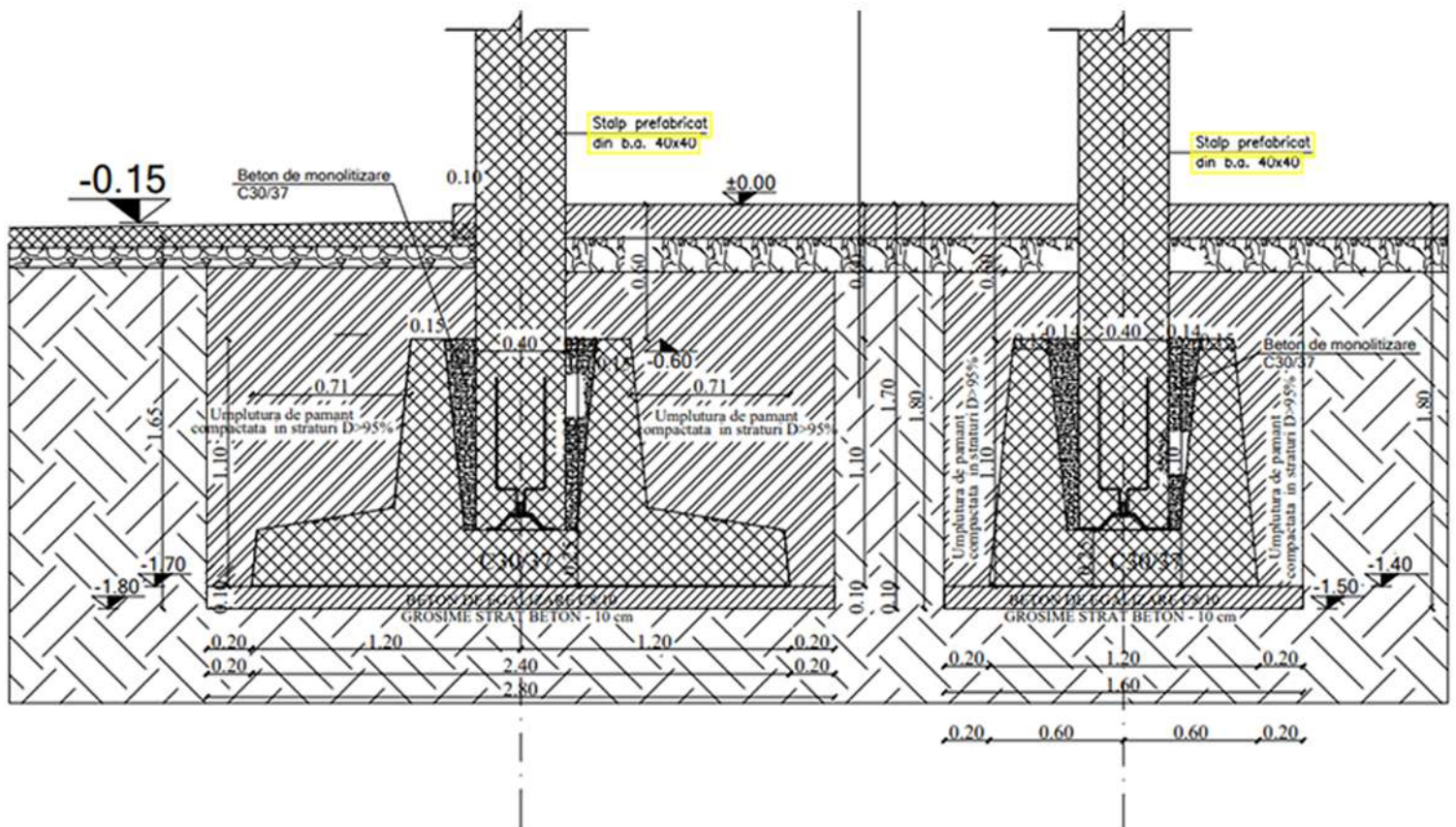

STÂLPI BETON

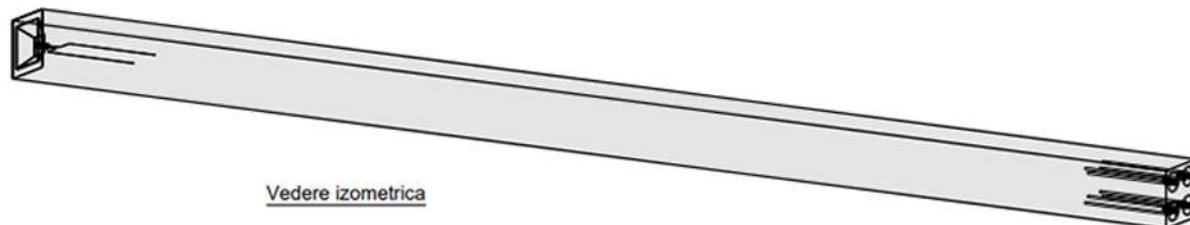

Vedere izometrica

Dimensiuni stâlpi

30 x 30

35 x 35

40 x 40

45 x 45

50 x 50

55 x 55

STÂLPI CU INSERT PENTRU PLANȘEU

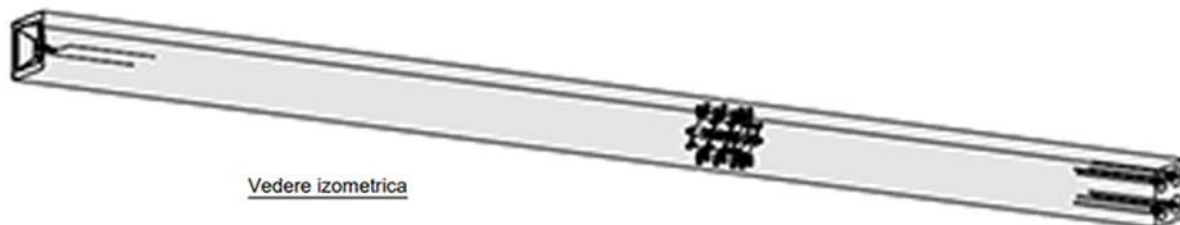

Vedere izometrica

STRUCTURĂ MIXTĂ (FERME METALICE)

Deschidere între 15-25 mp

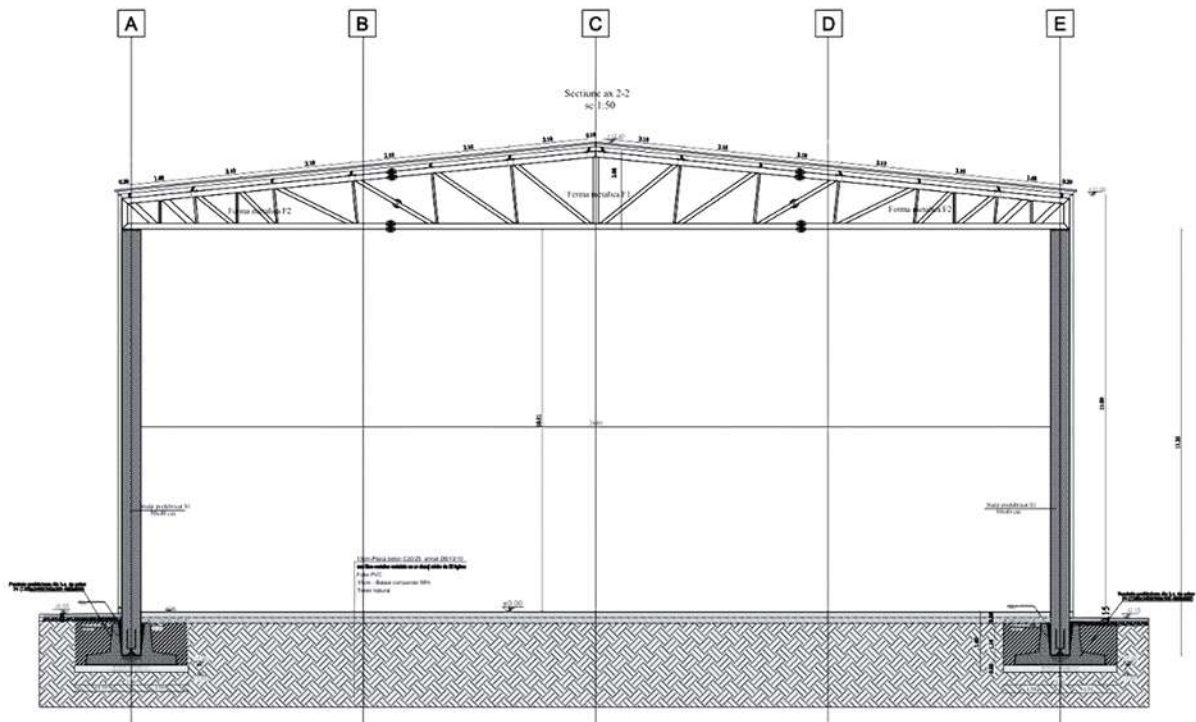

METAL

FUNDAȚII PREFABRICATE (OBELIX) PENTRU STRUCTURI METALICE

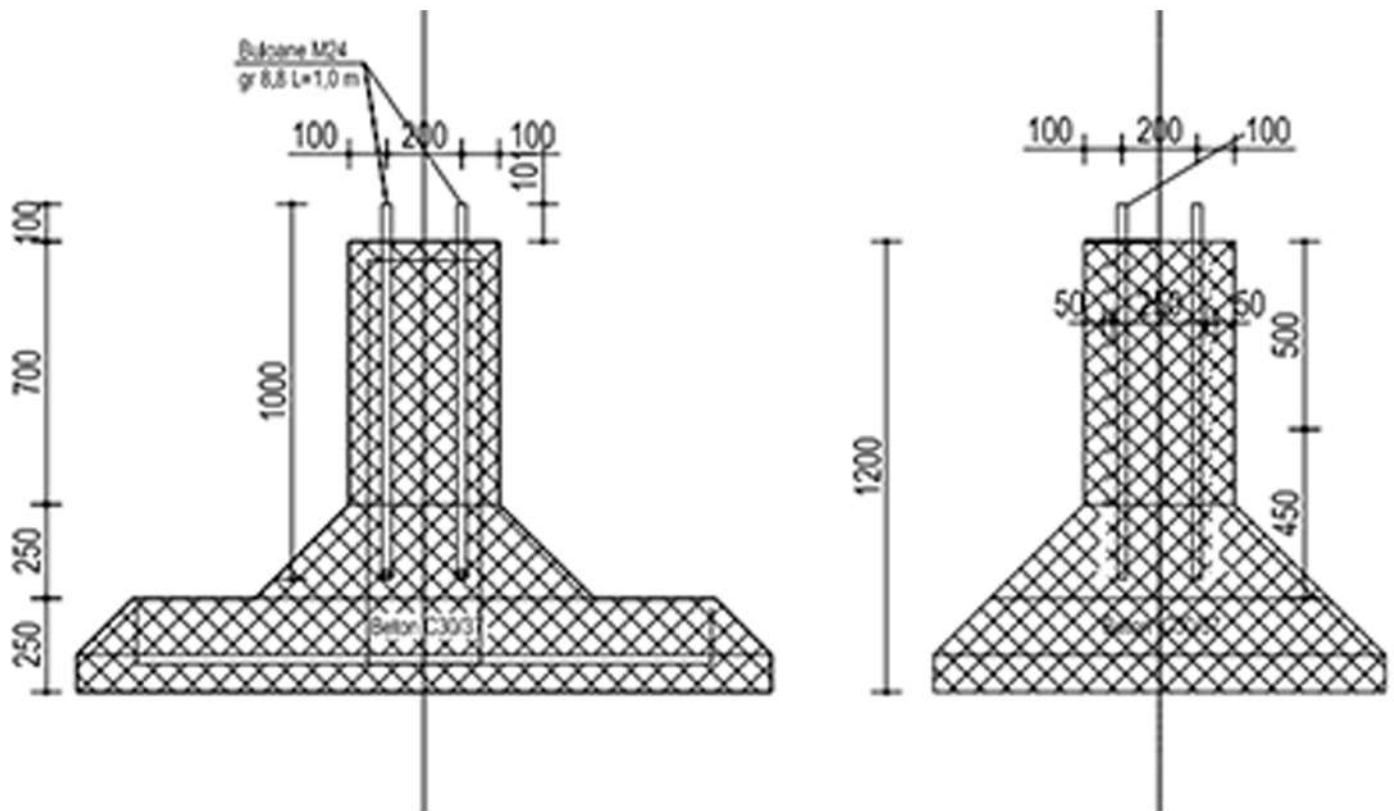

HALE DIN PROFILE METALICE

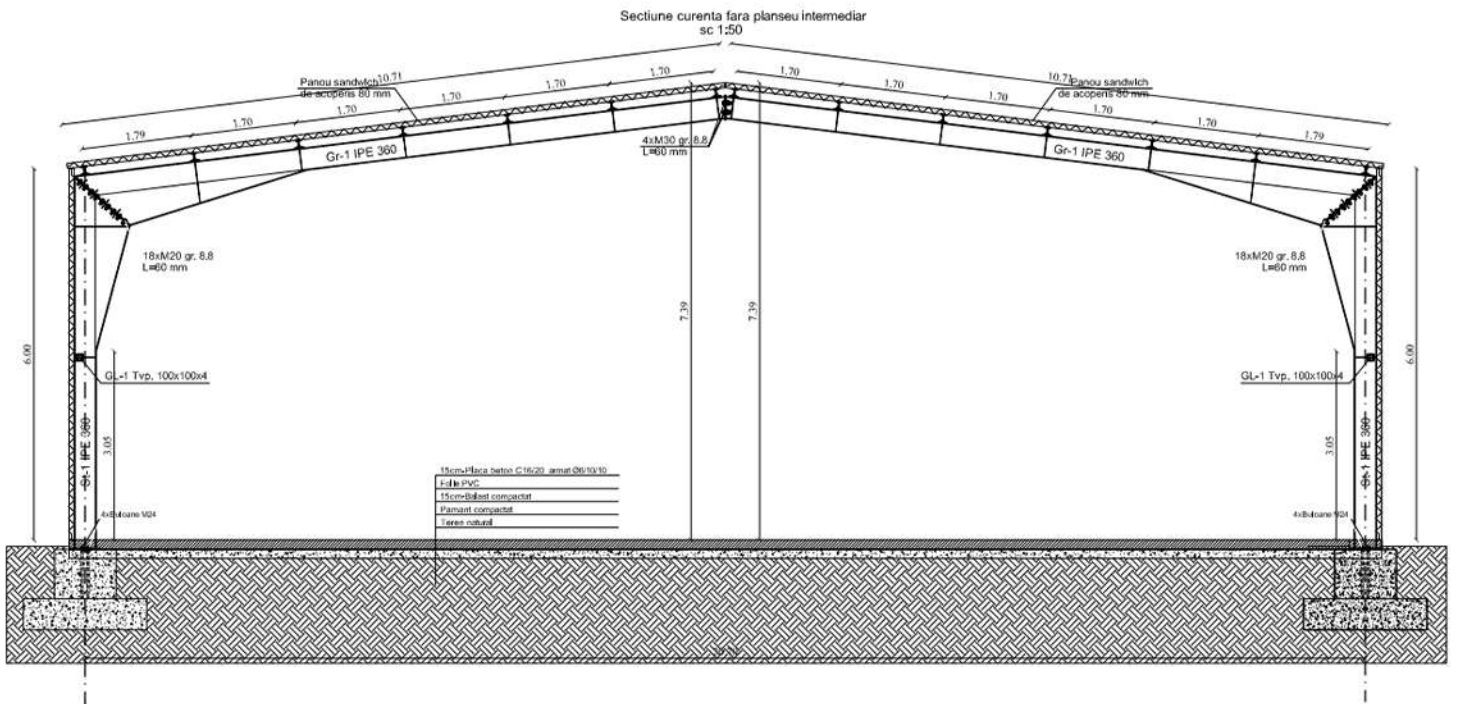

CONTACT

ESTE MOMENTUL SĂ TRANSFORMĂM VIZIUNEA TA ÎN REALITATE!

Birou Cluj-Napoca: Str. Ștefan Mora, nr. 6, Cluj-Napoca

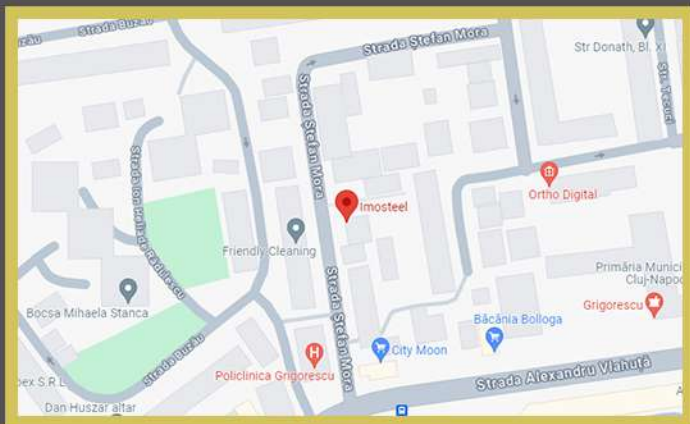

Fabrică: Str. Laminoriștilor, nr. 145, Câmpia Turzii

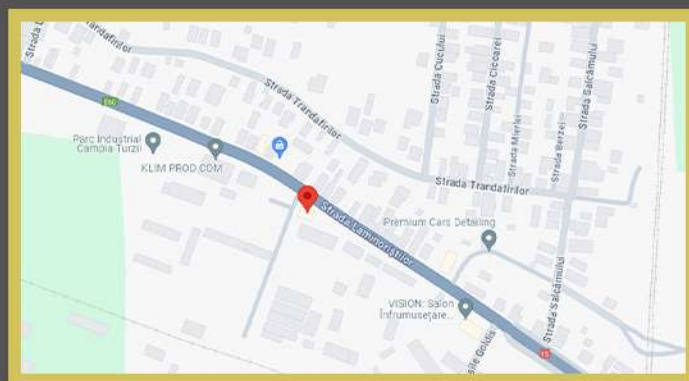

RASLAN AMIN

☎ 0772 020 011
✉ ofertareimosteel@gmail.com
🌐 www.imosteel.ro

DASCĂL DARIUS

☎ 0757 575 081
✉ darius@imosteel.ro
🌐 www.imosteel.ro

IMOSTEEL SRL - RO 2871710 - J12/1484/24.03.1992